

VIBRATION MANAGEMENT CORPORATION

3532-A EAST TC JESTER , BROOKWOOD BUSINESS PARK , HOUSTON , TEXAS 77018 , U.S.A

INTERNET ADDRESS: www.vimco.biz

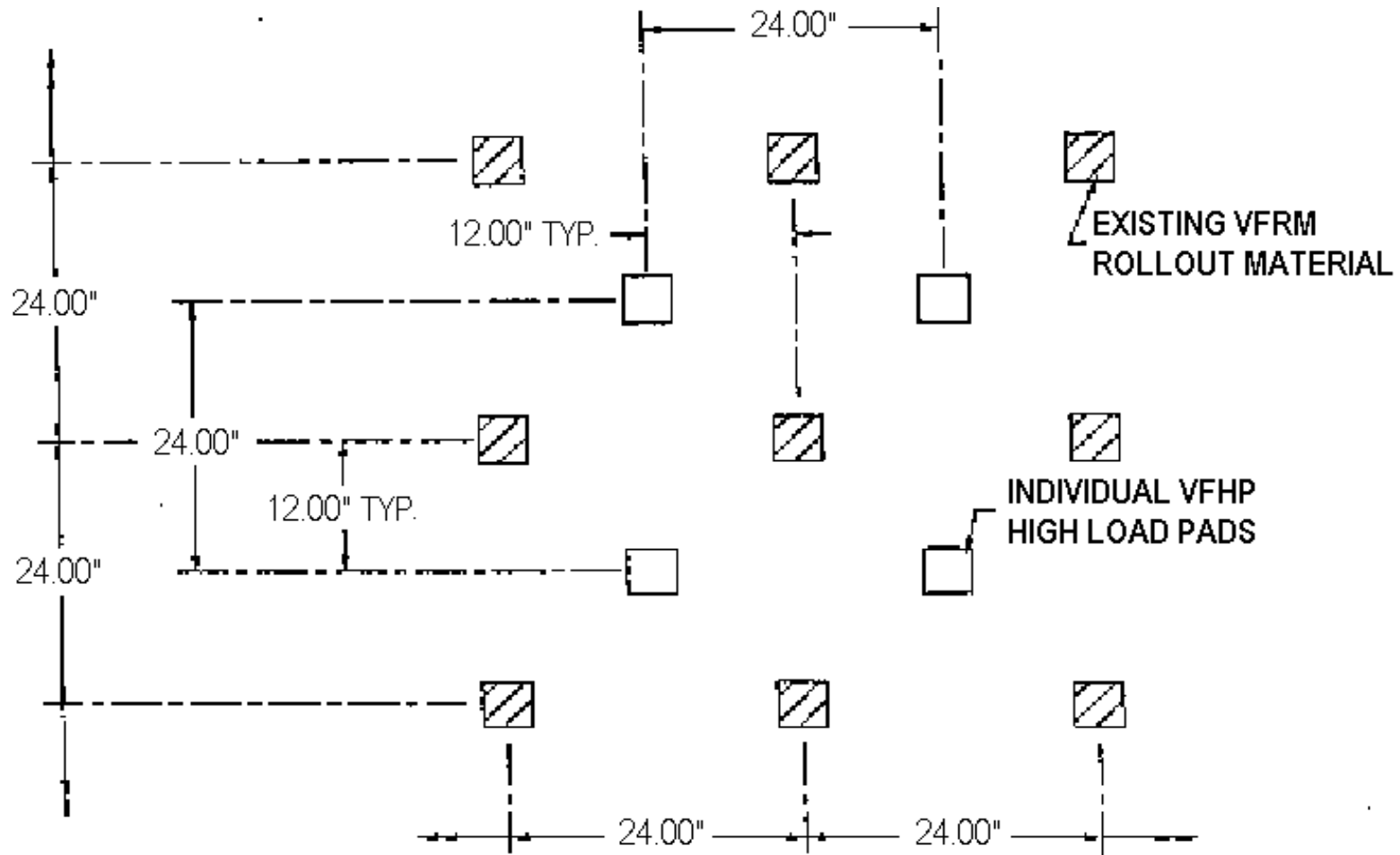

Notes / Remarks :

Project :
 Client :
 Consultant :
 Representative :

Title : High Load Pad Layout on
VFRM-24 Rollout Material
 (24" spacing)

Drawing no.
S-2600.07

Rev. 1